

# SLPVG0058G

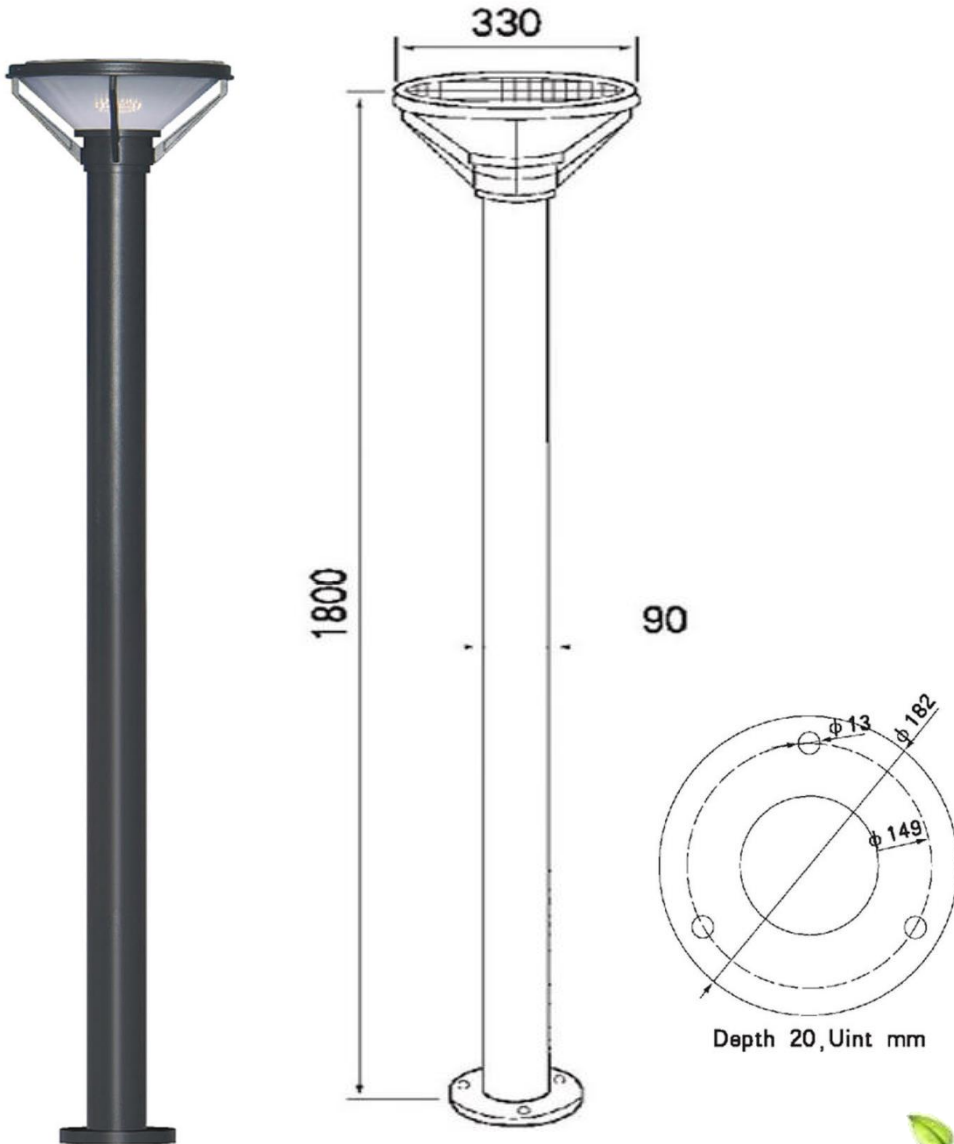

*No Wiring .... No electricity!*

## Solar Garden Pole Light

### Features:

SensLights solar garden lights source chip from Senslights ,golden wire,BSOB wire bond.

Mon crystalline solar panel, we only use grade A solar.  
Die casting aluminum, electrostatic spraying for salt spray proof.

Intelligent light control and timer control. The light switch on in the evening and switch off in the morning by detecting the day and night.  
The lighting time and power is customizable.

More than 36H autonomy with lithium battery inside .100% safe. No explosion risk. Optional LiFipo battery

Easy installation. No trenching and cabling. Money saver.

Nobody does lighting quite the way SensLights does, which has championed the use of LEDs in everything from domestic bulbs to its versatile Hue smart lighting. Its solar lights are brighter than most rivals and come in various styles such as downward-facing posts, upward-facing lights and more industrial wall-mounters.

This wall light has a big solar panel on top, meaning you get more light for longer from the LED for a good six hours. It's simple to set up and has great build quality. You can also choose a version with a built-in motion sensor. Strong enough to easily see if that's an olive or a beetle in your salad.



# SLPVG0058G

*No Wiring .... No electricity!*



## Solar Garden Pole Light

### Technology Parameters :

- Solar Panel :** 9v 7w high efficiency ,
- Light Source :** SensLights, LEDs 4w ,18mil
- Luminous Flux:** 440lm ~ 550lm
- Color Temperature :** 3500 ~7500K
- Induction Angle and Distance (beam Angle) :** 120 Degree
- Battery :** 4.5V x 6.4mAh battery
- Discharging time:** 23 ( 100% Power)
- Charging time:** 4-6hrs (1000w/m<sup>2</sup>)
- Product Material:** 6063 Aluminum PC
- Work Temperature:** -20°C-65°C
- Protect Level:** IP65
- Control Mode :** Light Control

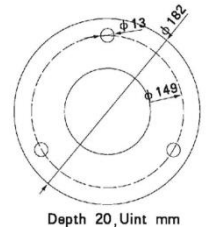
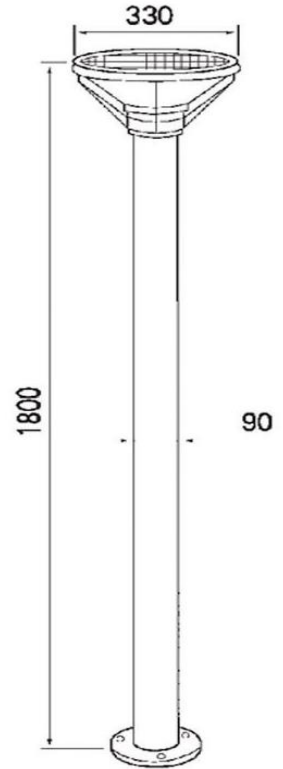

[www.senslights.com](http://www.senslights.com)  
[sales@senslights.com](mailto:sales@senslights.com)

# SLPVG0058G



*No Wiring .... No electricity!*

## Solar Garden Pole Light

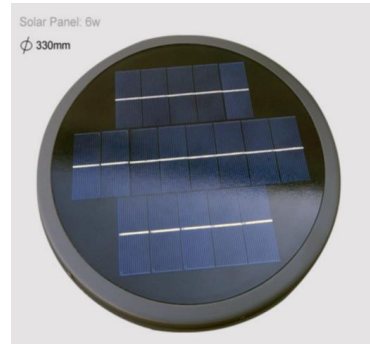

[www.senslights.com](http://www.senslights.com)  
[sales@senslights.com](mailto:sales@senslights.com)

*No Wiring .... No electricity!*

## Solar Garden Pole Light

### 1. Maintenance / Cleaning

Switch off the luminaire before maintenance and cleaning.

Repairs should only be carried out by qualified persons and using genuine spare parts. Inappropriate repairing could cause significant danger.

#### **WARNING:**

The use of any accessory not specified in this manual may present a risk of personal injury. Cleaning of solar panel in summer / winter Changing rechargeable battery Long-time storage (exposure to light, charge/discharge cycle)

If you need any support please contact: [support@senslights.com](mailto:support@senslights.com)

### 2. Others (Service, Repairing, Guarantee, etc ...)

-Have your product repaired by a qualified person This electric product is in accordance with the relevant safety requirements. Repairs should only be carried out by qualified persons using original spare parts, otherwise this may result in considerable danger to the user. - Please contact the SensLights store which you bought the product for after sale services if any. Or contact: [support@senslights.com](mailto:support@senslights.com)



## Quality Certification Multitasking Corporation test report

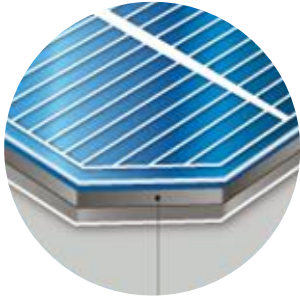

Multitask Solar Panel

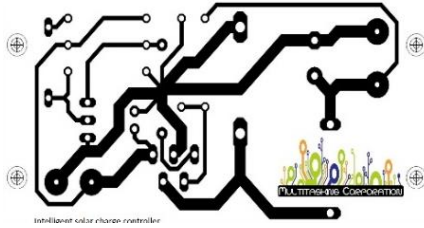

Intelligent Solar controller

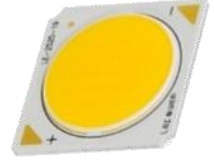

SensLights LED Chip



Energy saving rating



Green Energy Products



Green & Eco Friendly Products



LED chip bright and Lumen testing



Quality Standard



No Wiring No electricity!



Solar Powered Products

